

Digital Converter Box

User's Manual



See Back
Cover for
SPECIAL
OFFER!



⚠ IMPORTANT NOTICE

**Digital Converter Box will
automatically shut off**

- For energy savings the unit is shipped with sleep mode enabled at four hours as required by the governing agency. To adjust the setting or turn sleep mode off. **See pg 14**

Table of Contents

Introduction	3
Warnings/Safety	5-7
Getting Started	8
Battery Installation	8
Converter Box	9
Remote	10
Connection	11
Converter Box Installation	11
Setup	12
Navigating the Menu	13
Apps	13
Channels	14
Screen Format	15
Parental Control	15-16
Closed Caption	17
Time Zone	18
Factory Default	18
Features	19
Troubleshooting	20-21
FCC	22
Specifications	23
Warranty	23



The Digital Transition

Congratulations you are now prepared for the digital transition. When analog signals end, you will not be left with a blank screen on the TV. Instead, the GE Digital Converter Box will receive the new digital signals and convert them so you can continue to watch free “over-the-air” broadcasts on your analog TV.

It is truly an exciting time in television history. In the same way, the black & white transformation to color dramatically improved the TV. Digital Television will heighten your TV experience.

Advantages digital television has to offer include superior picture quality, improved sound quality, electronic programming guide and more channels. That’s right! Depending on the broadcast area; you may receive two, three, or even four more times the channels.

Thank you for choosing GE!

Safety Precautions

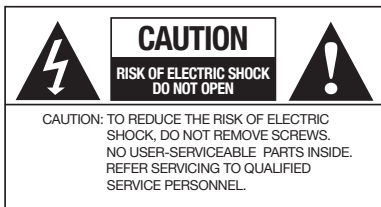

The lightning flash with arrowhead symbol within an equilateral triangle, is intended to alert the user to the presence of uninsulated “dangerous voltage” within the product’s enclosure that may be of sufficient magnitude to constitute a risk of electric shock to persons.



The exclamation point within an equilateral triangle is intended to alert the user to the presence of important operating and maintenance (servicing) instructions in the literature accompanying the product.



WARNING:

To prevent fire or shock hazard, do not expose this device to rain or moisture. Dangerous voltage is present inside the product. Do not remove the product enclosure.

CAUTION:

Insert the power plug into the wall outlet with AC power of 120V/50-60HZ. The AC plug is polarized and will only go in the socket one way. Contact a licensed electrician, if you can not get the plug to fit securely in the socket.

Important Safety Notes

1. INSTRUCTIONS:

Read and follow all safety and operating instructions before operating this product. Heed all warnings on the product and all warnings contained in the user's manual. Be sure to keep these instructions for future reference.

2. CLEANING:

Use a dry cloth only.

3. VENTILATION OPENINGS:

Never block the ventilation openings on the enclosure of the product. Do not place anything on top of the product. Avoid operating the Digital Converter Box in enclosed areas like cabinets and bookcases. Do not place the product on soft surfaces such as a bed, sofa, carpet, rug, near drapes, curtains, or walls.

4. OBJECT AND LIQUID ENTRY:

Never push objects of any kind into the ventilation openings of this product. Doing so may result in personal or property damage or injury, including fire or electrical shock. Never spill liquid of any kind on the product.

5. HEAT:

Install product away from any heat sources such as radiators, heat registers, stoves, or other devices that generates heat. Avoid placing the Digital Converter Box on top of all potential heat sources like amplifiers.

6. POLARIZED PLUG:

For safety reasons, this product is equipped with a polarized alternating current line plug with one blade wider than the other. It will only fit into the AC wall socket one way. Do not attempt to defeat the safety feature of the polarized plug. If you have difficulty fully inserting the plug, contact a licensed electrician for help.

7. POWER CORD PROTECTION:

The power cord of this product should be routed to avoid being walked on or pinched at plugs, receptacles and the point where exiting from the Digital Converter Box.

8. ATTACHMENTS:

Only use attachments and accessories recommended by the manufacturer.

Important Safety Notes

9. LIGHTNING:

Power surges that may occur due to lightning can damage sensitive electronics. Unplug the product from wall power and disconnect the antenna from the Digital Converter Box during lightning storms and when unused for long period of times.

10. SERVICING:

There are no user serviceable parts within this product. This product should be serviced by qualified personnel only. Do not attempt to service this product yourself. Servicing is required when the product has been damaged in any way, such as power supply cord or plug is damaged, liquid has been spilled or objects have fallen into the Digital Converter Box, the Digital Converter Box has been exposed to rain or moisture, does not operate normally, or has been dropped.

11. OVERLOADING:

Do not overload wall outlets, extension cords or convenience receptacles as this can result in a risk of personal or property damage or injury, including fire or electric shock. Always operate any electrical device in accordance with applicable electrical codes.

12. WATER AND LIQUIDS:

Do not use this product near any sources of water such as a bath tub, kitchen sink, swimming pool, basement, washing machine. Never expose the apparatus to dripping or splashing or place items such as vases, aquariums, any other item filled with liquid, or candles on top of the Digital Converter Box.

Important Safety Notes

13. ELECTRIC SHOCK:

Do not remove the enclosure of the product. There are no user-serviceable components. All service/repair should be carried out by qualified personnel.

14. POWER SOURCE:

Use only the type of power source indicated in the product specifications. If you are uncertain about the power supplied to your home, consult a certified electrician.

15. SMOKE:

If the device should emit smoke or unusual odor, immediately disconnect the power cord from the wall outlet. Have the Digital Converter Box serviced by a licensed technician.

16. BATTERIES:

Spent or discharged batteries must be recycled or disposed of properly in compliance with all applicable laws. For detailed information, contact your local county solid waste authority.

17. Keep a 4 inch minimum distance around the Digital Converter Box for sufficient ventilation

18. Outdoor Antenna Grounding:

If the outside antenna is connected to the digital Converter Box, make sure the antennas system is grounded. This will provide some protection against built-up static charges and voltage surges. Article 810 of the National Electrical Code, ANS/NFPA 70 provides information with regard to proper grounding of the mast and supporting structure, grounding of the lead-in wire to an antenna-dicharge unit, size of grounding conductors, location of antenna-dicharge unit, connection to grounding electrode, and requirements for the electrode.

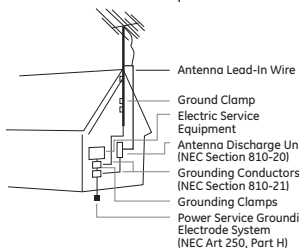

Getting Started

Below are all the items that are included with your Digital Converter Box

Remote

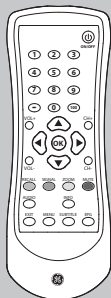

"AAA" batteries



Smart Digital Converter Box - 22729 or
Digital Converter Box - 22730

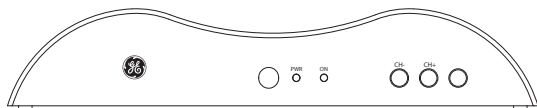

RF Cable

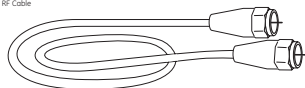

You can use a composite audio/video cable instead of the RF cable if your TV is compatible. (Not Included)

Installing the Remote batteries

1. On the back of the remote, push up on the tab and lift the cover off.
2. Match the batteries to the + and - marks inside the battery case, then insert 2 "AAA" Alkaline batteries.
3. Press the battery cover back into place.

CAUTION

Batteries may leak harmful liquids or ignitable materials or explode causing injury and product damage.

- Do not mix old and new or other battery types.
- Replace all batteries at the same time.
- Replace fully discharged batteries immediately.

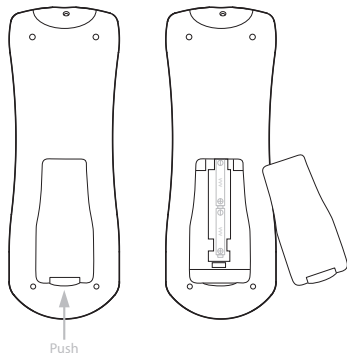

Converter Box

Front

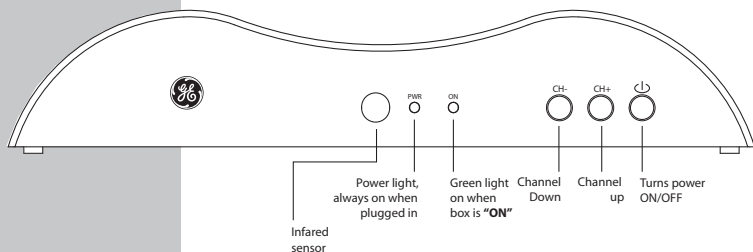

Back

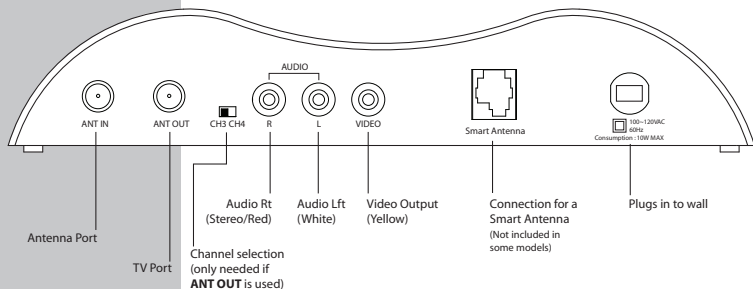

Digital Converter Box will shut off automatically

For energy savings the Digital Converter Box is shipped with sleep mode enabled at four hours as required by the governing agency. To adjust the setting or turn sleep mode off go to pg 14.

Remote Control

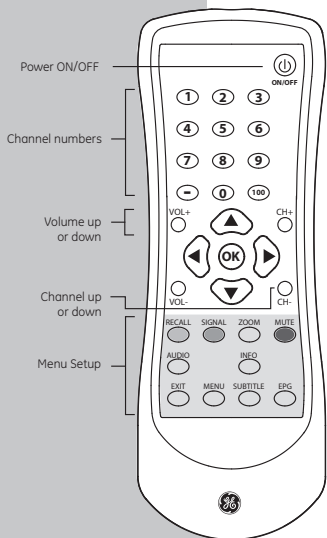

Power ON/OFF - Turns the Smart Digital Converter Box ON or OFF.

OK - Executes the selected option in menu or enters the value in any input mode or it displays the channel list while watching a program.

VOL+/VOL- - Increases or decreases the volume out of the Digital Converter Box.

CH-/CH+ - Goes up or down through the channel numbers.

Menu Setup

RECALL - Return to previous channel

SIGNAL - Check signal reception strength of the channel you are watching. Use to optimize placement of the antenna.

ZOOM - Choose between three screens settings letter box, full and center.

MUTE - Turns sound off.

AUDIO - Function not available on these models.

INFO - Program information of the selected channel.

EXIT - Returns to the previous Menu within the larger menus.

MENU - Displays the main Menu on screen.

SUBTITLE - Displays closed caption text.

EPG - Use to display the Simple Guide.

Connecting Converter Box

1. Connect either a standard antenna into the **ANT IN** port or a Smart Antenna into both the **Smart Antenna** port and **ANT IN** port.
2. Connect the TV from the **ANT OUT** port to TV's.
3. Select channel 3 or 4 on the converter box (choose the channel not used in your area). Turn your TV to the same channel
4. Plug-in to AC

Connecting TV with RF Cable (included)

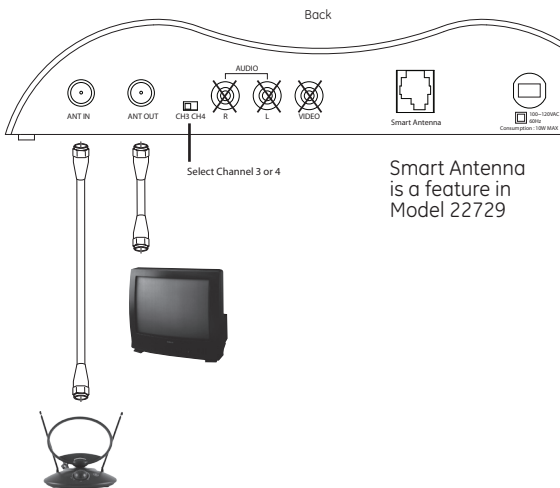

1. Connect either a standard antenna into the **ANT IN** port or a Smart Antenna into both the **Smart Antenna** port and **ANT IN** port.

2. Connect from the converter box to the TV's A/V inputs using Composite Cables (make sure that the color matches the port).

3. Set TV to proper input

4. Plug-in to AC

Connecting TV with Composite Audio/Video Cables (not included)

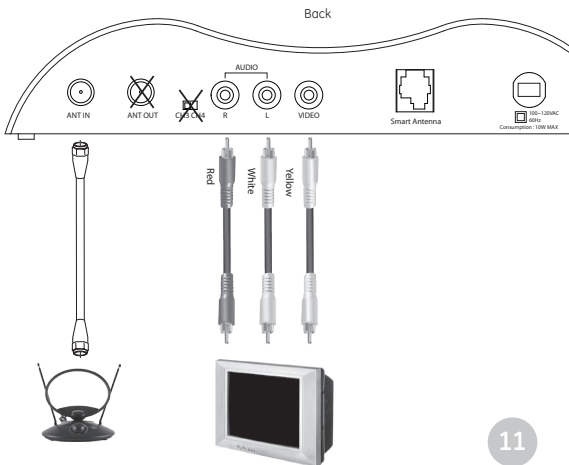

Setting up the Converter Box on Screen

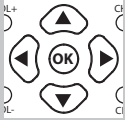

Arrows let you navigate through the menu screens.

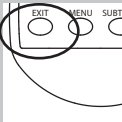

Setup

When first plugged-in the menu guide will show up on the screen. First, you will need to choose a **“Quick”** or **“Custom”** install. **“Quick”** is recommended for most users .

1. Choose either **“Quick”** or **“Custom”** Install.
2. If you choose the Quick install hit the OK button.

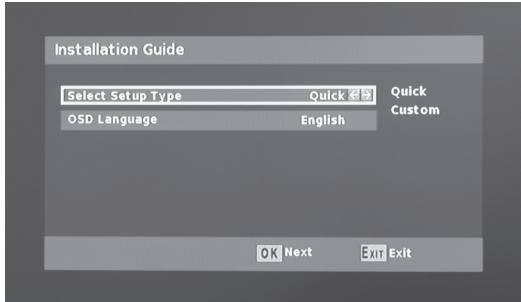

Now that you are in the Scan screen

1. The initial scanning will take about three to four minutes. While the Converter Box is scanning, it is programming your new HD channels. When the scanning is complete, press **“EXIT”** to start viewing your TV.

Digital Converter Box will shut off automatically

For energy savings the Digital Converter Box is shipped with sleep mode enabled at four hours as required by the governing agency. To adjust the setting or turn sleep mode off go to pg 14.

Navigating the Menus

1. Press the **"MENU"** button on the remote. The screen below will appear.



2. Use the **"Up/Down"** arrow buttons to select either Channel, Setup, or Info. Press **"OK"** on the remote.

3. Use the **"Up/Down"** arrow buttons to navigate to the desired option. Press **"OK"** on the remote.

4. Once the desired setting has been selected using the arrow button, press the **"EXIT"** key to return to the settings menu or press menu key to return to normal operation. Settings will automatically be stored in memory.

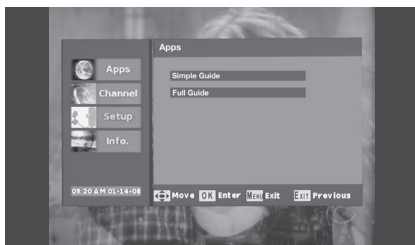

Menu Options

Menu : Apps : Simple Guide

1. This feature displays programming information for current channel.

Menu : Apps : Full Guide

2. This feature displays programming information for current and different channels. When broadcasted, up to 8 days of programming information may be viewed.

Menu Options

Channel

Menu : Channel : Auto

1. Use this feature to scan for all available channels. This feature is used during the setup process and typically does not need to be repeated.

Menu : Channel : Manual

2. Use this feature to scan for a specific channel. Digital channels may be broadcasted at a different frequency than the old analog channel. This means, for example, channel 5 may be broadcasted where channel 32 used to be. The automatic scan feature is recommended for most users.

Menu Options

Menu : Setup : Screen Setting : Screen Format

1. Choose the format you prefer for your TV. There are three sizes, Letter box, Full, or Center.

3 Screen Formats

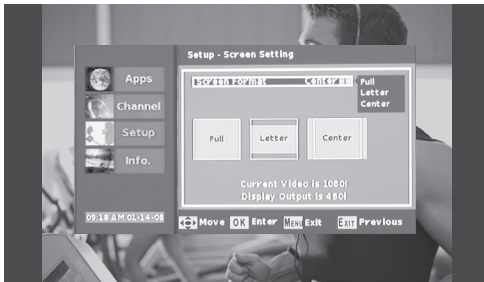
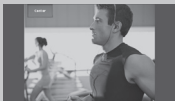

Note: Use "EXIT" on your remote to return to previous menu screen.

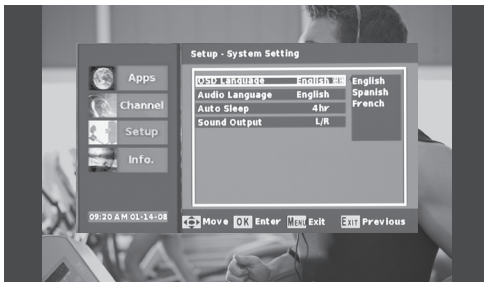
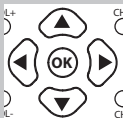

Menu Options

Screen Format

Menu : Setup : System Setting : OSD Language

Language: English, Spanish, or French

Select the language of the Converter Box text.

Menu : Setup : System Setting : Audio Languages

Audio Languages:

Displays the audio language chosen in either English, Spanish, or French.

Menu : Setup : System Setting : Auto Sleep

Auto Sleep:

Default setting is 4 hours, you can adjust it to your needs or turn it off.

Menu Option

Menu : Setup : Parental Control

1. This is a great feature for parents that want to control what their children view. You will need to put in a password to access this function. The factory setting is "1234".

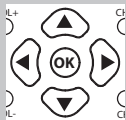

Each of the rating setting pages are easy to maneuver thru, use the arrow key to your selection. Press "OK" when you would like to choose your selection.



The rating control allows you to pick what parental advisories that will be off limits to the kids. You will get up to 3 different rating scales to choose from:

TV Rating: (FV, V, S, L, D)

- (FV) - Fantasy Violence
- (V) - Violence
- (S) - Sexual Situations
- (L) - Coarse Language
- (D) - Suggestive Dialogue

MPAA Rating: (G, PG, PG-13, R, NC-17, X, NR)

Digital Rating: (7+, 10+, 13+, 16+)

The Parental controls allows you to lock certain channels, block specific movies or programs based on different ratings that are available.

Menu Option

Parental Control

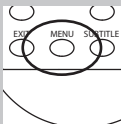

Setting up Parental Control:

- A. Enter your pass code and turn on "Lock System"
- B. Select either "TV Rating or MPAA Rating", and press **"OK"** on the remote.
- C. Using the arrow left and right, you can arrow over until "Allow All" is highlighted and arrow down to select "Block All".
- D. Icons of locks will appear in all the blue squares to indicate those channels and ratings have been blocked.
- E. Or use the up and down arrows to select the level of rating. Use the left and right arrow to highlight the blue box that you want to lock out; press **"OK"** and an icon of a lock will appear in the box. Repeat this step to continue to block out other ratings.
- F. Press the **"EXIT"** button on the remote to return to the settings menu or press menu key to return to normal operation. Settings will automatically be stored in memory.

Menu : Setup : Parental Control : Change Password

1. To change your password from the default **"1234"**. Use the arrow keys up/down to select. The change password box will pop up, use your number keys to change the password. Re-enter your new password to confirm.

Menu : Setup : Closed Caption

Closed caption formats types:

1. Analog mode (NTSC-CC)

Types of analog closed captions are TT1, TT2, TT3, TT4, CC1, CC2, CC3, and CC4

2. Digital Mode (ATSC-CC)

Types of digital closed caption are Service 1-5

Menu Option

Closed Caption

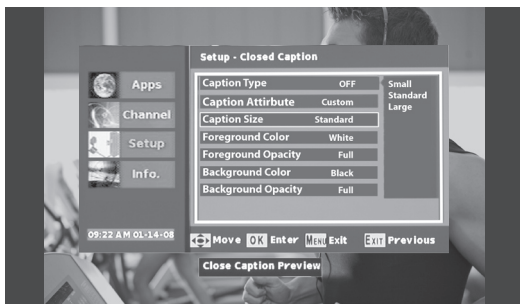

One of the benefits to Digital Closed Caption is the display of captioning can be customized to the viewers needs.

Caption Size

Captions can be displayed in different Font sizes, options are:

Small, Standard or Large.

Foreground Color

Captions can be displayed in different Font color:

Red, Green, Blue, Yellow, Magenta,
Cyan, Black and White.

Foreground Opacity

Opacity will allow different shades of opaqueness of the text. Options for Text opacity are;

Full High Half Low Zero.

Background Color

Caption can be displayed in different Font colors:

Red, Green, Blue, Yellow, Magenta,
Cyan, Black and White.

Menu Option

Time Zone

Menu : Setup : Time Zone

Time Zone:

This function lets you choose which time zone that you are located in. **Hawaii, Alaska, Pacific, Mountain, Central, or Eastern.** Press the "EXIT" key to return to the settings menu or press menu key to return to normal operation. Settings will automatically be stored in memory.

Daylight Savings Time:

Auto daylight savings time function provides daylight savings time in summer, and automatically switches back to the normal timings in Winter. This option only works for areas that support daylight savings.

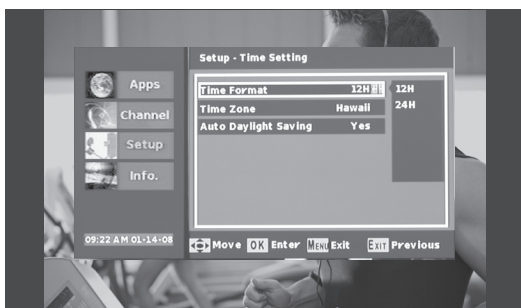

Menu : Setup : Factory Default

1. Resets all settings back to factory default.

Features

Features

Antenna strength Indicator

Press the **"SIGNAL"** button on the remote. A screen will appear and give you the details of the signal quality and signal strength of the current channel. Use this feature to optimize the antenna placement.

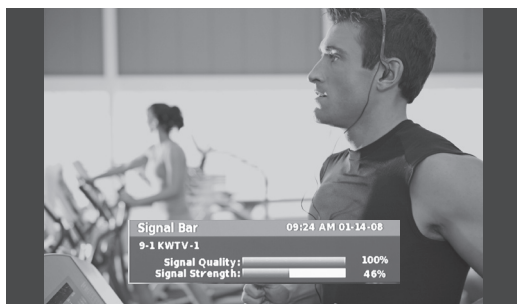
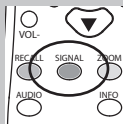

Picture breaks up and freezes frequently.

- This indicates poor antenna reception.
- Use the signal indicator feature to determine optimum position of receiving antenna.
- A better antenna may be required.
- Some channels may not have sufficient signal in your area.

Message box : No signal

- Signal is not strong enough to view.
- Adjust the antenna

Poor sound quality or no sound

- Make sure TV volume is turned up to a reasonable level.
- Make sure volume on converter box is at medium level.
- Adjust the levels of TV volume and Digital Converter Box volume to find optimum combination of volumes to eliminate any noise.
- If using composite outputs, verify connections of left and right composite inputs are hooked up correctly.
- Make sure mute button is not enabled on TV or Digital Converter Box.

Remote control does not work

- Install new batteries in the remote.
- Ensure batteries are aligned correctly, refer to instructions (pg 8).

The Digital Converter Box box does not go to the channel entered on the remote.

- With digital broadcasting each channel can now have sub-channels. This requires the use of the **"DASH"** button when selecting a channel. For example, to watch channel 5, enter 5-1 on the remote.

Digital Converter Box box will not turn on

- Push the power button and wait 5 seconds.

Trouble Shooting

Digital Converter Box requires a short amount of time to turn-on.

- Verify the Digital Converter Box is plugged into AC power.
- Make sure remote has fresh batteries.

Does not receive specific channel anymore

- Use the signal indicator to optimize placement of the antenna
- A better antenna may be required.
- Some channels may not have sufficient signal in your area.

Digital Converter Box shuts off automatically

- For energy savings the Digital Converter Box is shipped with sleep mode enabled at four hours as required by the governing agency. To adjust the setting or turn sleep mode off go to pg 14.

Error message reads no TV channels

- Make sure you have an antenna connected to the Digital Converter Box.
- Adjust your antenna and re-scan for channels.
- Try a different/better antenna and re-scan for channels.

It takes several seconds for a picture to appear when I change channels

- This is normal.
- Digital signals have to be decoded unlike the old analog signals.

If you press a command on the remote and the converter performs a previous command

- The Digital Converter Box didn't see the full command. Release the button, make sure the remote is pointed at the Digital Converter Box. Re-press the command again. You may need to reposition the Converter Box to be facing you.

Additional assistance can be found at www.jascoproducts.com

Any unauthorized changes or modifications to the equipment would void the user's warranty and may conflict with both state and federal laws. The GE Digital Converter Box complies with part 15 of the FCC rules. Operation is subject to the following conditions:

- 1) The GE Digital Converter Box may not cause harmful interference.
- 2) The GE Digital Converter Box may accept any interference received including interference that may cause undesired operation.

NOTE: This equipment has been tested and found to comply with the limits for a Class B digital device, pursuant to Part 15 of the FCC Rules. These limits are designed to provide reasonable protection against harmful interference in a residential installation. This equipment generates, uses and can radiate radio frequency energy and, if not installed and used in accordance with the instructions, may cause harmful interference to radio communications. However, there is no guarantee that interference will not occur in a particular installation. If this equipment does cause harmful interference to radio or television reception, which can be determined by turning the equipment off and on, the user is encouraged to try to correct the interference by one or more of the following measures:

- Reorient or relocate the receiving antenna.
- Increase the separation between the equipment and receiver.
- Connect the equipment into an outlet on a circuit different from that to which the receiver is connected.
- Consult the dealer or an experienced radio/TV technician for help

Specifications

BROADCAST SIGNAL CONVERSION	ATSC input/ NTSC output
DEMODULATION METHOD	8-VSB
VIDEO OUTPUT	RF Output (Coax) Composite Video
ANTENNA INPUT	75 ohm F-connector
POWER REQUIREMENT	AC 120V, 50/60Hz
POWER CONSUMPTION	10 watts, max/ Standby Mode: 2 watts max
DIGITAL CONVERTER BOX DIMENSIONS	8.27 X 5.12 x 1.77 inches 21 x 13 x 4.5 cm
WEIGHT	2.2 lbs/1Kg



is a trademark of the General Electric Company and is used under license to Jasco Products Company LLC, 10 E. Memorial Road, Oklahoma City, OK 73114.

This Jasco product comes with a 1 year limited warranty. Visit www.jascoproducts.com for details.

22729-3
22730-3